

ACCESORIOS



INT



Interruptores de seguridad paro-marcha.

- Interruptores para instalar al lado del ventilador, y de esta forma poder cortar la corriente antes de manipular el ventilador.
- De acuerdo a la norma IEC947-3.
- Protección IP-65
- Ventiladores trifásicos: Interruptor de 6 polos y contacto auxiliar.
- Ventiladores monofásicos: Interruptor de 3 polos y contacto auxiliar.

Modelo	Intensidad (A)	(Kw)	Entrada cables (mm)
INT-CA10/3CA	20	5,5	19
INT-KG10/3CA	20	5,5	23
INT-KG20/3CA	25	7,5	29
INT-KG32/3CA	32	11	29
INT-KG41/3CA	40	15	37,5
INT-KG64/3CA	63	22	37,5
INT-KG80/3CA	80	30	37,5
INT-KG100/3CA	100	37	37,5
INT-CA10/6CA	20	5,5	19
INT-KG10/6CA	20	5,5	23
INT-KG20/6CA	25	7,5	29
INT-KG32/6CA	32	11	29
INT-KG41/6CA	40	15	37,5
INT-KG64/6CA	63	22	37,5
INT-KG80/6CA	80	30	37,5
INT-KG100/6CA	100	37	37,5

IAT

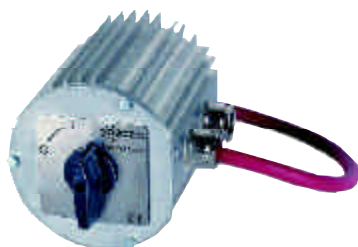

Interruptor de seguridad para 200° C/2h

- Interruptor con certificación LGAI según Norma Europea EN 12101-3 con el número de expediente 2202837.
- Construido según normas VDE, IEC, BS, UTE, KEMA
- Montado dentro de caja estanca de aluminio, con aletas de ventilación para mejorar el aislamiento térmico.
- Protección IP-54
- Mando frontal giratorio
- Preparado para maniobras de conexión y desconexión bruscas
- Multipolar: 6 polos y 12 contactos
- Tensión máxima 500 V A.c.

Características técnicas

Modelo	Intensidad (A)
IAT-200/16	16
IAT-200/32	32
IAT-200/63	63

RM



Reguladores electrónicos de velocidad

La serie de reguladores RM está especialmente diseñada para la variación de la velocidad, por control de fase en los ventiladores con motores de alimentación monofásica.

Los modelos RM son reguladores manuales monofásicos, están diseñados y fabricados según las Directivas de Compatibilidad Electromagnética 89/366/CEE y 92/31/CEE y la Directiva de la baja tensión 73/23/CEE.

- Caja de plástico de fácil desmontaje.
- Conexión por regletas.
- Conmutador paro/marcha.
- Ajuste de velocidad mínima.
- Protección de sobreintensidad por fusible.
- Filtro EMC.
- Reguladores según normas EN 60335 y EN 55014.

Los reguladores están preparados para una carga mínima de 0,5 A/fase. En caso de una carga inferior, los reguladores desconectarán iluminándose el indicador.

Características técnicas

Modelo	Tensión entrada	Protección	Intensidad máxima (A)
RM-1	230 V-50/60 Hz	IP-54	3
RM-2	230 V-50/60 Hz	IP-54	5
RM-3	230 V-50/60 Hz	IP-54	10

Dimensiones mm

Modelo	Dimensiones		
	A	B	C
RM-1	80	145	80
RM-2	96	164	85
RM-3	96	164	85

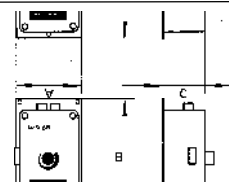

ACCESORIOS



RAP

Reguladores electrónicos automáticos de velocidad

Los reguladores serie RAP están concebidos para la regulación de ventiladores con motores monofásicos, por control de fase y en función de la temperatura mediante microprocesador, pudiendo controlar además un sistema de calefacción.

RAP-650: Protección IP-44. Control por microprocesador. Mandos selectores mediante pulsadores de membrana. Alarma de temperatura.

RAP-1200: Protección IP-65. Control por microprocesador. Mandos selectores mediante pulsadores de membrana. 8 alarmas diferentes. Mantenimiento de datos programados.
RAA-1200: Protección IP-65. Unidad auxiliar de ampliación de potencia.



RAP-650

RAP-1200

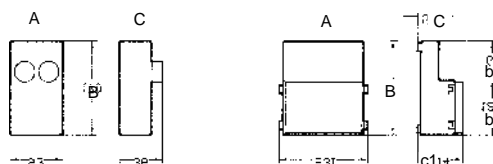

Dimensiones

Modelo	Tensión entrada	Protección	Intensidad máxima (A)
RAP-650	220 V-50/60 Hz	IP-44	6,5
RAP-1200	220 V-50/60 Hz	IP-65	12,0
RAA-1200	220 V-50/60 Hz	IP-65	12,0

Modelo	A	B	b1	b2	C	c1
RAP 650	93	170	-	-	36	-
RAP 1200	231	186	125	61	114	50

RFM RFT



Convertidores de frecuencia

La serie de convertidores RFM y RFT, son especialmente apropiados para la variación de velocidad mediante tensión y frecuencia, de ventiladores helicoidales y centrífugos trifásicos. Diseñados y fabricados según las Directivas de Compatibilidad Electromagnética 89/336/CEE y 92/31/CEE y la Directiva de baja tensión 73/23/CEE.

Filtros EMC según normas EN 50081 y EN 50082.

Motores eléctricos con convertidores de frecuencia

- En general, todos los ventiladores SODECA con motor trifásico en ejecución normal, son adecuados para trabajar alimentados con convertidor de frecuencia estático (según IEC 60034-17). No obstante algunos motores requieren medidas especiales. La máxima frecuencia o velocidad de funcionamiento, nunca deberá exceder la de diseño del ventilador. Las aplicaciones con par cuadrático tales como ventiladores y bombas, cuando varía la velocidad, la potencia absorbida es directamente proporcional al cubo de la velocidad de rotación:
 $P_{a2} = P_{a1} (n_2 / n_1)^3$
- El aislamiento de los motores acoplados a los ventiladores es suficiente para trabajar sin restricciones con convertidor de frecuencia hasta tensiones de ≤ 500 V. Se aplica lo mismo para trabajar con convertidores de pulsos controlados AC, donde el tiempo de subida del pulso de tensión - voltage pulse rise time - $t_s > 0,1 \mu s$ en los terminales del motor. La utilización de filtros senoideales a la salida del convertidor, contribuirán en el buen funcionamiento del motor, minimizando averías y aumentando la vida útil del mismo. Se recomienda que para motores de tamaño ≥ 225 , estos sean solicitados con devanados especiales para funcionar con convertidor de frecuencia.
- La longitud de los cables de salida del convertidor al ventilador, influyen especialmente en las características de la tensión en bornes del motor. La definición de "cables largos" dependerá del valor nominal y tipo de convertidor, siendo necesario consultar la documentación técnica del fabricante.
- Para los motores Antideflagrantes EEx-d, estos deben solicitarse para ser accionados mediante convertidor de frecuencia. El fabricante del motor pedirá información de la aplicación mediante un cuestionario, para definir los parámetros de trabajo. Además dichos motores deberán llevar incorporadas sondas PTC.
- Los motores de seguridad aumentada EEx-e, no pueden accionarse con convertidor de frecuencia (para ello sería necesario la certificación conjunta motor y convertidor).

Dimensiones mm.

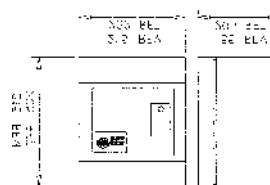

CARACTERÍSTICAS GENERALES			
SERIE		RFM	RFT
ALIMENTACIÓN	Tensión:	Monofásica 220V -15% a 240V +10%	Trifásica 3x380V-15% a 440V+10%
	Frecuencia:	40-70Hz	40-70Hz
SALIDA TRIFÁSICA	Tensión:	de 0 a la tensión de entrada	de 0 a la tensión de entrada
	Frecuencia máx.:	60 Hz	60 Hz
PARAMETROS DE AJUSTE		Velocidad máxima y mínima Rampas Limitación térmica	Velocidad máxima y mínima Rampas Limitación térmica
MODO DE CONTROL		Análogo	Digital
PARAMETROS DE VISUALIZACIÓN		Velocidad en % o r/min.	Frecuencia de salida en Hz Velocidad en % Valor tensión de salida en %
PROTECCIONES DE ENTRADA		Térmico de entrada	Térmico de entrada
PROTECCIONES DE SALIDA	Volaje:	sobretensión	sobretensión
	Control:subto:	entre fases	entre fases/fase-tierra
	Intensidad máx.:	estandar	estandar
	I _{xt} :	estandar	estandar
	Etapa control:	aislada galvánicamente	aislada galvánicamente
FORMA CONSTRUCTIVA	Protección:	IP-54	IP-54
	Refrigeración:	Natural	Forzada
PESO APROX. (Kg)		3,5	4,9

Modelo	Potencia máx. motor		Corriente salida máx. (A)
	kW	3x230V CV	
RFM-075	0,55	0,75	3,4
RFM-1,5	1,10	1,5	5,5
	3x400V		
RFT-2	1,50	2,0	3,8
RFT-3	2,20	3,0	5,6
RFT-4	3,00	4,0	7,0
RFT-5,5	4,00	5,5	9,5

ACCESORIOS



PL

Persianas de sobrepresión

La persiana de sobrepresión se instala directamente sobre la pared en que descansa el ventilador. Estas persianas se abren por el flujo de aire y se cierran cuando el ventilador está en reposo. La construcción es en material termoplástico. En los modelos 80, 90 y 100 velocidad máxima recomendable 12 m/seg.

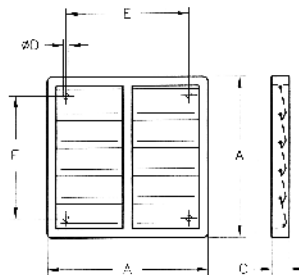

Modelo	Dimensiones					Aplicable a los modelos				
	A	C	ØD	E	F	HEP	HCD	HC	HRE	HCH
PL-20	240	28	5,2	193	167	-	20	-	-	-
PL-25	294	26	5	232	232	25	25	25	25	-
PL-31	347	26	5	276	276	31	30	31	31	-
PL-35	397	26	5	310	310	35	35	35	35	35
PL-40	459	26	5	364	364	40	40	40	-	40
PL-45	501	26	5	395	395	45	-	45	-	45
PL-50	549	31	5	445	445	50	-	50	-	-
PL-56	605	28	5	522	522	56	-	56	-	56
PL-63	696	31	5	626	626	63	-	63	-	63
PL-71	760	40	5	692	692	-	-	71	-	71
PL-80	840	40	5	772	772	-	-	80	-	80
PL-90	940	40	5	872	872	-	-	90	-	90
PL-100	1040	40	5	972	972	-	-	100	-	100

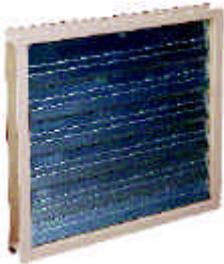

P

Persianas de sobrepresión

La persiana de sobrepresión se instala directamente sobre la pared en que descansa el ventilador. Estas persianas se abren por el flujo de aire y se cierran cuando el ventilador está en reposo.

La construcción del marco es en chapa de hierro y las lamas en chapa de aluminio. El modelo 100, velocidad máxima recomendable 18 m/seg.

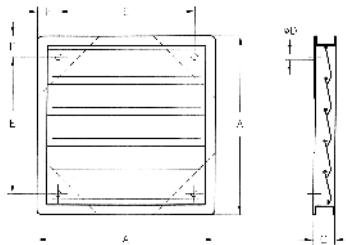

Modelo	Dimensiones					Aplicable a los modelos							
	A	C	ØD	E	F	HEP	HCD	HC	HRE	HCH	HCDF	HDF	
P-25	290	51	6	187	51,5	25	25	25	25	-	25	-	
P-35	400	51	6	266	67	31/35	30/35	31/35	31/35	35	31/35	-	
P-45	500	51	6	347	76,5	40/45	40	40/45	-	40/45	40/45	-	
P-56	600	51	6	447	76,5	50/56	-	50/56	-	56	50/56	-	
P-71	780	72	6	605	87,5	63	-	63/71	-	63/71	63	71	
P-90	970	72	6	755	107,5	-	-	80/90	-	80/90	-	80/90	
P-100	1070	72	6	850	110	-	-	100	-	100	-	-	

R



Rejilla protección normalizada para situar en la aspiración

Previene contra contactos con la hélice y posibles entradas de objetos. Construida en varilla electrosoldada y de dimensiones normalizadas según DIN 24 167.

Modelo	Aplicable a los modelos	
	HC	HCH/HDF
R-35/B	-	35
R-40	-	40
R-45	-	45
R-56	-	56-4T/M-0,75, 56-4T-1, 56-6T/M-0,33, 56-6T-0,5, 56-6T-0,75
R-56 - 1,5	-	56-4T-1,5, 56-4T-2
R-63 - 0,5	-	63-4T-1, 63-6T/M-0,5, 63-6T-0,75
R-63 - 1,5	-	63-4T-1,5, 63-4T-2, 63-6T-1
R-63 - 4	-	63-4T-3, 63-4T-4
R-71	-	71-4T-1,5, 71-4T-2, 71-6T/M-0,75, 71-6T-1, 71-6T-1,5
R-71/C	71	-
R-71-3	-	71-4T-3, 71-4T-4
R-80	-	80-6T-1, 80-6T-1,5, 80-8T-0,5, 80-8T-0,75
R-80/C	80	-
R-80 - 5,5	-	80-4T-3, 80-4T-4, 80-4T-5,5, 80-6T-2, 80-6T-3, 80-8T-1
R-90	-	90-4T-4, 90-4T-5,5, 90-6T-2, 90-6T-3, 90-8T-1, 90-8T-1,5, 90-8T-2
R-90/C	90	-
R-90 - 7,5	-	90-4T-7,5, 90-4T-10, 90-6T-4, 90-8T-3
R-100	-	100-6T-3, 100-8T-1,5, 100-8T-2
R-100/C	100	-
R-100-7,5/C	100 4T/H	-
R-100 - 10	-	100-4T-7,5, 100-4T-10, 100-6T-4, 100-6T-5,5, 100-8T-1,5, 100-8T-2
R-100 - 20	-	100-4T-15, 100-4T-20

ACCESORIOS



RI

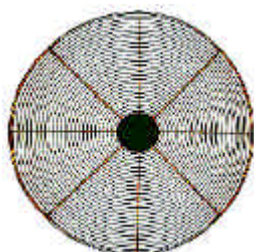

Rejilla protección normalizada para situar en la impulsión

Previene contra contactos con la hélice y posibles entradas de objetos exteriores. Construida en dimensiones normalizadas según DIN 24 167.

Aplicable a los modelos

Modelo	HEP	HCD	HC	HRE	HCH	HCDF	HDF
RI-20	-	20	-	-	-	-	-
RI-25/E	-	-	-	25	-	-	-
RI-25	25	25	25	-	-	25	-
RI-31/E	-	-	-	31	-	-	-
RI-31	31	30	31	-	-	31	-
RI-35/E	-	-	-	35	-	-	-
RI-35/B	-	-	-	-	35	-	-
RI-35/C	35	35	35	-	-	35	-
RI-40	40	40	40	-	40	40	-
RI-45	45	-	45	-	45	45	-
RI-50	50	-	50	-	-	50	-
RI-56	56	-	56	-	56	56	-
RI-63	63	-	63	-	63	63	-
RI-71	-	-	71	-	71	-	71
RI-80	-	-	80	-	80	-	80
RI-90	-	-	90	-	90	-	90
RI-100	-	-	100	-	100	-	-

RT

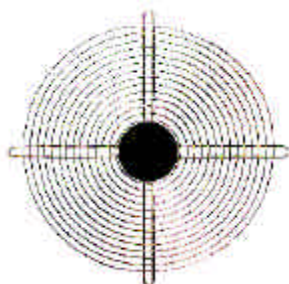

Rejilla de protección normalizada para situar en la aspiración/impulsión

Previene contra contactos con la hélice y posibles entradas de objetos exteriores. Construida en dimensiones normalizadas según DIN 24 167.

Aplicable a los modelos

Modelo	HEPT	HCT	HGT	HPX	THT
RT-25	-	25	-	-	-
RT-31/B	-	31	-	-	-
RT-31	31	-	-	-	-
RT-35	35	35	-	35	-
RT-40	40	40	-	-	40
RT-45	45	45	-	45	45
RT-50	50	50	-	50	50
RT-56	56	56	-	56	56
RT-63	63	63	-	63	63
RT-71	-	71	-	71	71
RT-80	-	80	-	80	80
RT-90	-	90	-	90	90
RT-100	-	100	-	100	100
RT-125	-	-	125	-	125
RT-125/CC	-	-	125	-	125

PS

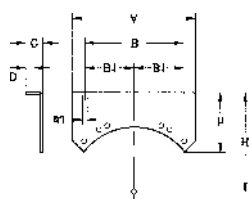

Pie de soporte para ventiladores tubulares

Al fijarse a la brida, posibilita la fijación sobre superficies planas.

Dimensiones

Aplicable a los modelos

Modelo	A	B	B1	C	D	h	H	ØJ	HEPT	HCT	HGT	HPX	THT
PS-25/31	275	225	-	30	13	120	195	10	-	25	-	-	-
	275	225	-	30	13	120	221,5	10	-	31	-	-	-
	275	225	-	30	13	120	239	10	31	-	-	-	-
PS-35/40	240	200	-	40	17	75	245	12	35	35	-	35	-
	240	200	-	40	17	75	270,5	12	40	40	-	-	40
PS-45/50	450	400	200	40	17	175	328	12	45	45	-	45	45
	450	400	200	40	17	175	355	12	50	50	-	50	50
PS-56/63	520	430	215	45	20	242	425	14	56	56	-	56	56
	520	430	215	45	20	242	472,5	14	63	63	-	63	63
PS-71	620	530	265	50	20	228	530	16	-	71	-	71	71
PS-80	730	640	320	60	25	255	590	16	-	80	-	80	80
PS-90	780	690	345	70	30	273	650	18	-	90	-	90	90
PS-100	860	770	385	75	35	310	730	18	-	100	-	100	100
PS-125	1020	920	460	55	25	411	830	13	-	-	125	-	125

ACCESORIOS



PA

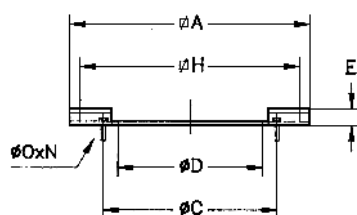

Placa de adaptación

Utilizada para el montaje de los accesorios PT, BTUB, B, BAC. Permite separar el ventilador de su base sin desmontar el conjunto de accesorios y tubería.

Modelo	Dimensiones							Aplicable a los modelos		
	$\varnothing A$	$\varnothing C$	$\varnothing D$	E	$\varnothing H$	$\varnothing O$	N	CHT	HT	CHRE
PA-345	345	200	165	20	245	M.8	4x90°	-	-	722
PA-390	390	210	190	20	320	M.8	4x90°	-	-	825
PA-440/250	440	280	249	20	360	M.6	4x90°	220/225	25	1131
PA-490	490	355	314	20	410	M.8	8x45°	-	31	-
PA-550	550	395	354	20	450	M.6	8x45°	250/315	35	1135/1240
PA-620	620	450	399	20	530	M.10	8x45	-	40	-
PA-700/500	700	560	499	20	590	M.10	12x30°	400/450	-	1445/1650
PA-700/450	700	500	449	20	590	M.10	8x45°	-	45	-
PA-790	790	560	499	20	680	M.10	12x30°	-	50	-
PA-890/630	890	690	629	20	750	M.10	12x30°	500	-	-
PA-890/560	890	620	559	20	750	M.10	12x30°	-	56	-
PA-990/630	990	690	629	20	850	M.10	12x30°	-	63	-
PA-990/710	990	770	709	20	850	M.10	16x22°30'	-	71	-
PA-1085	1085	770	709	20	850	M.10	16x22°30'	560/630	-	-
PA-1138/800	1138	860	799	25	1000	M.10	16x22°30'	-	80	-
PA-1138/900	1138	970	899	25	1000	M.12	16x22°30'	-	90	-
PA-1238	1238	1070	999	25	1100	M.12	16x22°30'	-	100	-

MS

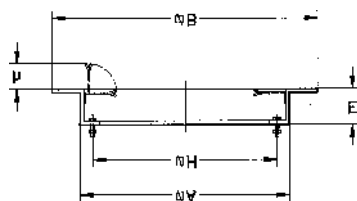

Marco soporte

Para facilitar el montaje del ventilador en los conductos de obra.

Modelo	Dimensiones					Aplicable a los modelos		
	$\varnothing A$	$\varnothing B$	E	$\varnothing H$	h	CHT	HT	CHRE
MS-348	348	520	60	295	70	-	-	722
MS-393	393	565	60	320	70	-	-	825
MS-443	443	615	60	360	70	200/225	25	1131
MS-493	493	665	60	410	70	-	31	-
MS-553	553	725	60	450	70	250/315	35	1135/1240
MS-623	623	795	60	530	70	-	40	-
MS-701	701	875	60	590	90	400/450	45	1445/1650
MS-791	791	965	60	680	90	-	50	-
MS-891	891	1065	60	750	90	500	56	-
MS-991	991	1165	60	850	90	-	63/71	-
MS-1086	1086	1260	60	850	90	560/630	-	-
MS-1140	1140	1314	60	1000	90	-	80/90	-
MS-1240	1240	1414	60	1100	90	-	100	-

OP



Obturadores de sobrepresión

Obturadores de cierre automático instalados en la impulsión actuando por gravedad.

Modelo	Aplicable a los modelos
OP-25	HT-25
OP-31	HT-31
OP-35	HT-35
OP-40	HT-40
OP-45	HT-45
OP-50	HT-50
OP-56	HT-56
OP-63	HT-63
OP-71	HT-71
OP-80	HT-80
OP-90	HT-90
OP-100	HT-100

ACCESORIOS



PT

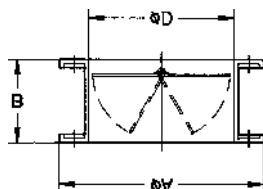

Obturadores de sobrepresión

Obturadores de cierre automático instalados en la aspiración, actuando por gravedad.

Aconsejable utilizar la placa de adaptación PA para su montaje.

Modelo	Dimensiones			Aplicable a los modelos	
	ØD*	ØA	B	CHT	CHRE
PT-160	160	220	150	-	722
PT-180	180	240	150	-	825
PT-250	250	310	150	200/225	1131
PT-355	355	435	200	250/315	1135/1240
PT-500	500	600	280	400/450	1445/1650
PT-630	630	730	355	500	-
PT-710	710	810	400	560/630	-

* Diámetro nominal tubería.

RPA



Rejilla de protección normalizada aplicada para situar en la aspiración

Aplicable a los modelos

Modelo	CMA		CMC		CB		CBP		CAST		CTMP		TCR	
	CMAT	CMC	CB	CBP	CAS	CMRT	CA	CAM	CMP	TCMP	CMT	CMR	TCR/R	
RPA-10	-	-	-	-	-	-	-	-	38	-	-	-	-	
RPA-11	218	-	-	-	-	-	-	-	-	-	-	-	-	
RPA-13	324	-	-	-	-	-	234	-	-	-	-	-	-	
RPA-15	325/426	-	-	-	242	-	142	-	512	-	-	-	-	
RPA-17	527	-	-	-	248	-	148	-	514	-	-	-	-	
RPA-18	528	-	-	-	254	-	154	-	-	-	-	-	-	
RPA-20	531	-	-	-	260	-	-	-	616	-	-	-	-	
RPA-23	540	628/630	-	-	680	-	160/166/172	540/545	718	-	922	-	-	
RPA-25	545	835/840	820	-	790	-	-	-	620/820	820	1025	-	-	
RPA-28	-	-	-	-	463/467	-	-	550/752	922	922	1128	-	-	
RPA-31	-	-	1428	-	571/640/645/650/980/1080	-	-	760	1025	1025	1231	-	-	
RPA-35	-	-	-	-	852/990/1090	-	-	-	1128	1128	1435/1640	-	-	
RPA-38	-	-	1733	-	-	1650	-	880	1231	1231	-	1031	-	
RPA-42	-	-	-	-	856	1856	-	-	1435	1435	1845	1135	-	
RPA-44	-	-	-	-	1250/A	2063	-	-	-	-	-	-	-	
RPA-47	-	-	2240	-	863/971	2271	-	-	1640	1640	2050	1240	1240	
RPA-48	-	-	-	-	1456/A	-	-	-	-	-	-	-	-	
RPA-52	-	-	-	1445	-	-	-	-	1845	1845	-	1445	1445	
RPA-55	-	-	-	-	-	2380	-	-	-	-	-	-	-	
RPA-60	-	-	-	1650	-	-	-	-	2050	2050	-	1650	1650	
RPA-65	-	-	-	1856	1663/A	-	-	-	-	-	-	1856	1856	
RPA-66	-	-	-	-	-	-	-	-	-	-	-	-	-	
RPA-73	-	-	-	-	-	-	-	-	2563	-	-	2063	2063	
RPA-81	-	-	-	-	-	-	-	-	-	-	-	2271	2271	
RPA-88	-	-	-	-	-	-	-	-	-	-	-	2380	-	

Previene contra contactos con la turbina y posibles entradas de objetos exteriores. Construida en dimensiones según DIN 24 167.

BD



Brida de acoplamiento doble

De aplicación en boca de aspiración, facilita la instalación al conducto.

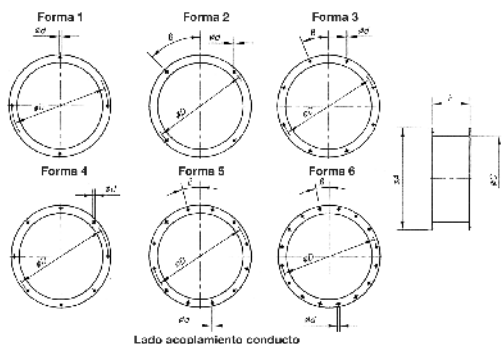

Lado acoplamiento conducto

	ØA	ØC	ØD	Ød	F	β	Forma	CB	CMP	CTMP	TCMP	CMR	TCR	TCR/R	CMC
BD-112	160	112	137	7	60	45°	2	-	512	-	-	-	-	-	-
BD-140	190	140	165	6.5	80	45°	2	-	514	-	-	-	-	-	-
BD-160	220	160	185	7	80	45°	2	-	616	-	-	-	-	-	-
															625/630
BD-180	210	180	205	7	80	45°	2	-	718	-	-	-	-	-	-
BD-200	260	200	225	7	80	45°	2	820	620/820	820	-	-	-	-	-
															835/840
BD-224	280	224	254	7	80	-	1	-	922	922	-	-	-	-	-
BD-250/1									1025	1025	-	-	-	-	-
BD-250/2	310	250	280	10	80	45°	2	1428	-	-	-	-	-	-	-
BD-280	350	280	320	10	100	-	4	-	1128	1128	-	-	-	-	-
BD-315/1	390	315	355	10	100	22°30'	3	1733	-	-	-	-	-	-	-
BD-315/2	390	315	355	10	100	-	4	-	-	-	-	1031	-	-	-
BD-315/3	390	315	355	10	100	22°30'	3	-	1231	1231	-	-	-	-	-
BD-355/1	430	355	395	10	100	-	4	-	-	-	-	1135	-	-	-
BD-355/2	430	355	395	10	100	22°30'	3	2240	-	-	-	-	-	-	-
BD-355/3									1435	1435	-	-	-	-	-
BD-400/1									1640	1640	-	-	-	-	-
BD-400/2	480	400	450	12	100	22°30'	3	-	-	-	-	1240	1240	-	-
BD-450/1									1845	1845	-	-	-	-	-
BD-450/2	530	450	500	12	100	22°30'	3	-	-	-	-	1445	1445	-	-
BD-500/1									2050	2050	-	-	-	-	-
BD-500/2	590	500	560	12	100	15°	5	-	-	-	-	1650	1650	-	-
BD-560	650	560	620	12	120	15°	5	-	-	-	-	1856	1856	-	-
BD-630/1									2563	-	-	-	-	-	-
BD-630/2	720	630	690	12	120	15°	5	-	-	-	-	2063	2063	-	-
BD-710	800	710	770	12	120	11°15'	6	-	-	-	-	2271	2271	-	-
BD-800	900	800	880	12	120	11°15'	6	-	-	-	-	2380	-	-	-

ACCESORIOS



BTUB



B

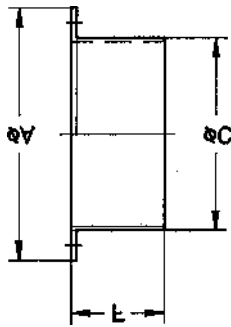

Brida de acoplamiento

De aplicación tanto en la boca de aspiración como en la de impulsión, facilita la instalación al conducto.

Modelo	Dimensiones			Aplicable a los modelos					
	ØC*	ØA	F	HEPT	HCT	HGT	THT	HPX	HT
BTUB-250	250	310	80	-	25	-	-	-	25
BTUB-280	280	350	80	-	31	-	-	-	-
BTUB-315	315	380	80	31	-	-	-	-	31
BTUB-355	355	430	80	35	35	-	-	35	35
BTUB-400	400	480	80	40	40	-	40	-	40
BTUB-450	450	530	80	45	45	-	45	45	45
BTUB-500	500	590	80	50	50	-	50	50	50
BTUB-560	560	650	80	56	56	-	56	56	56
BTUB-630	630	720	80	63	63	-	63	63	63
BTUB-710	710	800	80	-	71	-	71	71	71
BTUB-800	800	890	100	-	80	-	80	80	80
BTUB-900	900	1000	100	-	90	-	90	90	90
BTUB-1000	1000	1100	100	-	100	-	100	100	100
BTUB-1250	1250	1365	100	-	-	125	125	-	-

* Diámetro nominal tubería.

Aplicable a los modelos

Modelo	Dimensiones			Aspiración										Impulsión			
	ØC*	ØA	F	CHT	CHRE	CMAT CMA	CB	CAST CAS	CA	CAM	CM CTMP TCMP	CMT	CBP	TCR TCR/R CMR	CMRT	CMAT CMA	CA
B-52-E	52	100	67	-	-	-	-	-	-	-	-	-	-	-	-	-	234
B-63	63	110	60	-	-	-	-	-	-	-	-	-	-	-	-	218/224	142
B-80	80	150	60	-	-	113/114	-	-	-	-	-	-	-	-	-	229	-
B-80-E	80	150	60	-	-	-	-	-	-	-	-	-	-	-	-	118/117/80/158	-
B-100	100	150	60	-	-	305	-	-	231	-	-	-	-	-	-	128/127	-
B-100-E	100	170	60	-	-	-	-	245	142	-	-	-	-	-	-	-	172
B-112	112	150	60	-	-	725	-	218	178	-	512	-	-	-	-	-	-
B-125	125	180	60	-	-	527/528	-	254	154	-	-	-	-	-	-	528	-
B-140	140	180	60	-	-	-	-	-	-	-	514	-	-	-	-	-	-
B-150	150	210	60	-	-	581	-	265	160	-	628/630	-	-	-	-	531/510	-
B-160	160	220	60	-	-	-	-	-	-	-	516	-	-	-	-	-	-
B-160/1	160	270	60	-	722	-	-	680	-	-	-	-	-	-	-	-	-
B-180	180	240	60	-	825	540/545	-	795	108/172	540/545	718	922	-	-	-	545	-
B-200	200	260	60	-	-	-	320	763	-	-	620/620/535/570	1125	-	-	-	-	-
B-224	224	280	60	-	-	-	-	467	-	550/752	922	1128	-	-	-	-	-
B-250/1	250	310	80	-	-	-	-	717/640/645/690	-	-	-	1231	-	-	-	-	-
B-250/2	250	310	80	-	-	-	-	-	780	-	-	-	-	-	-	-	-
B-250/3	250	310	80	202/225	1131	-	-	-	-	-	1025	-	-	-	-	-	-
B-250/4	250	310	80	-	-	-	1426	-	-	-	-	-	-	-	-	-	-
B-250/5	250	310	80	-	-	-	-	980/1080	-	-	-	-	-	-	-	-	-
B-280/1	280	350	80	-	-	-	-	852	-	-	-	1755/1510	-	-	-	-	-
B-280/2	280	350	80	-	-	-	-	-	-	1128	-	-	-	-	-	-	-
B-280/3	280	350	80	-	-	-	-	990/1090	-	-	-	-	-	-	-	-	-
B-315/1	315	380	80	-	-	-	1733	-	-	-	-	-	-	-	-	-	-
B-315/2	315	380	80	-	-	-	-	-	880	-	-	-	-	-	1852	-	-
B-315/3	315	380	80	-	-	-	-	-	-	-	-	1601	-	-	-	-	-
B-315/4	315	380	80	-	-	-	-	-	-	1231	-	-	-	-	-	-	-
B-355/1	355	430	80	-	-	-	-	-	-	-	-	-	1185	1856	-	-	-
B-355/2	355	430	80	-	-	-	2240	863	-	-	-	-	-	-	-	-	-
B-355/3	355	430	80	260/315	1139/1240	-	-	895	-	-	1435	1945	-	-	-	-	-
B-355/4	355	430	80	-	-	-	-	1250/A	-	-	-	-	-	-	-	-	-
B-400/1	400	480	80	-	-	-	-	-	-	1670	-	-	-	-	-	-	-
B-400/2	400	480	80	-	-	-	-	-	-	-	-	-	1240	2063	-	-	-
B-400/3	400	480	80	-	-	-	-	971	-	-	2050	-	-	-	-	-	-
B-400/4	400	480	80	-	-	-	-	1456/A	-	-	-	-	-	-	-	-	-
B-450/1	450	530	80	-	-	-	-	-	-	1645	-	-	-	-	-	-	-
B-450/2	450	530	80	-	-	-	-	-	-	-	-	-	1445	-	-	-	-
B-450/3	450	530	80	-	-	-	-	-	-	-	-	1715	-	2271	-	-	-
B-500/1	500	590	80	-	-	-	-	-	-	2050	-	-	-	-	-	-	-
B-500/2	500	590	80	-	-	-	-	-	-	-	-	-	1650	-	-	-	-
B-500/3	500	590	80	-	-	-	-	-	-	-	-	-	-	-	-	-	-
B-500/4	500	590	80	102/150	1715/1550	-	-	-	-	-	-	-	-	-	-	-	-
B-500/5	500	590	80	-	-	-	-	-	-	-	-	-	-	2385	-	-	-
B-560/1	560	650	80	-	-	-	-	-	-	-	-	1855	-	-	-	-	-
B-560/2	560	650	80	-	-	-	-	-	-	-	-	-	1855	-	-	-	-
B-560/3	560	650	80	-	-	-	-	1645/A	-	-	-	-	-	-	-	-	-
B-630/1	630	720	80	-	-	-	-	-	-	2058	-	-	-	-	-	-	-
B-630/2	630	720	80	-	-	-	-	-	-	-	-	-	-	2062	-	-	-
B-630/3	630	720	80	505	-	-	-	-	-	-	-	-	-	-	-	-	-
B-710/1	710	800	80	-	-	-	-	-	-	-	-	-	-	2277	-	-	-
B-710/2	710	800	80	560/630	-	-	-	-	-	-	-	-	-	-	-	-	-
B-800	800	890	100	-	-	-	-	-	-	-	-	-	-	2380	-	-	-

* Diámetro nominal tubería recomendada.

ACCESORIOS



BIC

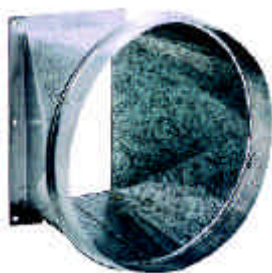

Brida de acoplamiento

Para acoplar a la boca de impulsión.

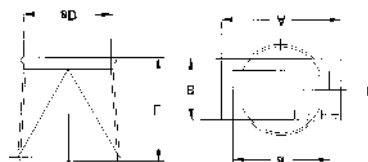

Modelo	Dimensiones						Aplicable a los modelos
	L	D	a	b	A	B	
BIC-820-CB	300	200	160	130	213	184	CB-820
BIC-1428	300	250	288	196	350	260	CB-1428
BIC-1733	300	280	340	242	412	315	CB-1733
BIC-2240	450	355	400	265	472	337	CB-2240
BIC-628	200	150	86	86	130	130	CMC-628
BIC-630	200	150	86	86	130	130	CMC-630
BIC-835	200	200	91	91	141	141	CMC-835
BIC-840	200	200	91	91	141	141	CMC-840
BIC-242	200	100	95	60	155	120	CAS/CAST-242
BIC-248	200	112	105	66	165	126	CAS/CAST-248
BIC-254	200	125	115	75	175	135	CAS/CAST-254
BIC-260	200	150	125	85	185	145	CAS/CAST-260
BIC-463	200	200	125	85	185	145	CAS/CAST-463
BIC-467	250	224	130	90	190	150	CAS/CAST-467
BIC-571	250	250	145	95	205	155	CAS/CAST-571
BIC-640	250	250	200	125	260	185	CAS/CAST-640
BIC-645	250	250	224	140	284	200	CAS/CAST-645
BIC-650	250	250	250	160	310	220	CAS/CAST-650
BIC-680	250	180	100	71	160	131	CAS-680
BIC-790	250	180	112	80	172	140	CAS-790
BIC-852	250	280	280	180	340	240	CAS/CAST-852
BIC-856	280	355	280	180	340	240	CAS/CAST-856
BIC-863	280	355	315	200	375	260	CAS/CAST-863
BIC-971	280	400	355	224	425	294	CAS/CAST-971
BIC-980	300	250	200	140	270	210	CAS/CAST-980
BIC-990	300	280	224	160	294	230	CAS-990
BIC-1080	300	250	200	140	270	210	CAS-1080
BIC-1090	300	280	224	160	294	230	CAS-1090
BIC-1250	450	400	400	280	480	360	CAS/CAST-1250/A
BIC-1456	450	450	450	315	530	395	CAS/CAST-1456/A
BIC-1663	450	500	500	355	580	435	CAS/CAST-1663/A
BIC-540	300	180	140	120	224	206	CAM-540
BIC-545	300	180	170	135	255	222	CAM-545
BIC-550	300	224	200	150	296	246	CAM-550
BIC-752	300	224	200	160	296	256	CAM-752
BIC-760	300	250	220	180	316	276	CAM-760
BIC-880	300	315	290	190	360	249	CAM-880
BIC-1445/E	450	450	450	355	538	445	CBP-1445
BIC-1650/E	450	500	400	400	590	490	CBP-1650
BIC-1856/E	450	560	560	450	660	550	CBP-1856

Modelo	Dimensiones						Aplicable a los modelos
	L	D	a	b	A	B	
BIC-512	300	112	86	72	118	106	CMP-512
BIC-514	300	140	107	83	147	122	CMP-514
BIC-616	300	160	125	103	172	153	CMP-616
BIC-620	300	200	100	105	153	159	CMP-620
BIC-718	300	180	146	115	192	169	CMP-718
BIC-820	300	200	160	130	213	184	CMP/TCMP-820
BIC-922	300	224	216	140	282	204	CMP/CTMP/TCMP-922
BIC-1025	300	250	250	165	314	229	CMP/CTMP/TCMP-1025
BIC-1128	300	280	300	180	364	244	CMP/CTMP/TCMP-1128
BIC-1231	300	315	320	200	384	266	CMP/CTMP/TCMP-1231
BIC-1435	300	355	280	228	344	294	CMP/CTMP/TCMP-1435
BIC-1640	300	400	320	250	404	336	CMP/CTMP/TCMP-1640
BIC-1845	450	450	360	284	444	370	CMP/CTMP/TCMP-1845
BIC-2050	450	500	450	315	545	412	CMP/CTMP/TCMP-2050
BIC-2563	450	630	600	410	706	512	CMP/CTMP-2563
BIC-922-T	300	180	216	140	282	204	CMT-922
BIC-1025-T	300	200	250	165	314	229	CMT-1025
BIC-1128-T	300	224	300	180	364	244	CMT-1128
BIC-1231-T	300	250	320	200	384	266	CMT-1231
BIC-1435-T	300	280	280	228	344	294	CMT-1435
BIC-1640-T	300	280	320	250	404	336	CMT-1640
BIC-1845-T	450	355	360	284	444	370	CMT-1845
BIC-2050-T	450	400	450	315	545	412	CMT-2050
BIC-1031	300	315	315	250	385	320	CMR-1031
BIC-1135	450	355	355	280	425	350	CMR-1135
BIC-1240	450	400	400	315	480	395	CMR/TCR/TCR-R-1240
BIC-1445	450	450	450	355	540	445	CMR/TCR/TCR-R-1445
BIC-1650	450	500	500	400	590	490	CMR/TCR/TCR-R-1650
BIC-1856	450	560	560	450	660	550	CMR/TCR/TCR-R-1856
BIC-2063	450	630	630	500	750	620	CMR/TCR/TCR-R-2063
BIC-2271	450	710	710	560	840	690	CMR/TCR/TCR-R-2271
BIC-2380	600	800	800	560	920	680	CMR-2380
BIC-2380/E	600	800	1120	560	1246	690	CMR-2380-X

BAC

Brida de acoplamiento elástica

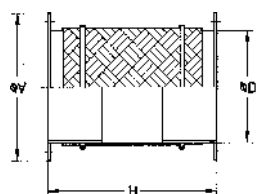

Modelo	Dimensiones			Aplicable a los modelos						
	ØD*	ØA	H	HEPT	HCT	HGT	CHT	HT	HPX	CHRE
BAC-160	160	220	340	-	-	-	-	-	-	722
BAC-180	180	240	340	-	-	-	-	-	-	825
BAC-250	250	310	340	-	25	-	200/225	25	-	1131
BAC-315/B	280	350	340	-	31	-	-	-	-	-
BAC-315	315	380	340	31	-	-	-	31	-	-
BAC-355	355	430	340	35	35	-	250/315	35	35	1135/1240
BAC-400	400	480	340	40	40	-	-	40	-	-
BAC-450	450	530	340	45	45	-	-	45	45	-
BAC-500	500	590	340	50	50	-	400/450	50	50	1445/1650
BAC-560	560	650	340	56	56	-	-	56	56	-
BAC-630	630	720	340	63	63	-	500	63	63	-
BAC-710	710	800	340	-	71	-	560/630	71	71	-
BAC-800	800	890	340	-	80	-	-	80	80	-
BAC-900	900	1000	340	-	90	-	-	90	90	-
BAC-1000	1000	1100	340	-	100	-	-	100	100	-
BAC-1250	1250	1365	340	-	-	125	-	-	-	-

* Diámetro nominal tubería.

ACCESORIOS



ACE



Brida de acoplamiento elástica.

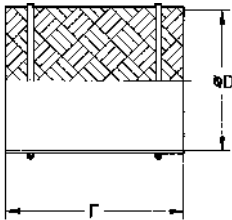

Aplicable a los modelos

IMPULSIÓN

Modelo	Dimensiones		CMAT CMA	CAS CAST	CA	CAM	CB	CMP	CMT	CMR	CMC	CMRT
	ØD*	L										
ACE-52	52	130	-	-	234	-	-	-	-	-	-	-
ACE-63	63	200	218/324	-	142	-	-	-	-	-	-	-
ACE-80	80	200	325	-	148/154 160/166	-	-	-	-	-	-	-
ACE-100	100	200	426/527	242	172	-	-	-	-	-	-	-
ACE-112	112	200	-	248	-	-	-	512	-	-	-	-
ACE-125	125	200	528	254	-	-	-	-	-	-	-	-
ACE-140	140	200	-	-	-	-	-	514	-	-	-	-
ACE-150	150	200	531/540	260	-	-	-	-	-	-	628/630	-
ACE-160	160	190	-	-	-	-	-	616	-	-	-	-
ACE-180	180	190	545	680/790	-	540/545	-	718	922	-	-	-
ACE-200	200	190	-	463	-	-	820	620/820	1025	-	835/840	-
ACE-224	224	190	-	467	-	550/752	-	922	1128	-	-	-
ACE-250	250	250	-	571/640/645 650/980/1080	-	760	1428	1025	1231	-	-	-
ACE-280	280	250	-	852/990/1090	-	-	1733	1128	1435/1640	-	-	-
ACE-315	315	250	-	-	-	880	-	1231	-	1031	-	1650
ACE-355	355	250	-	856/863	-	-	2240	1435	1845	1135	-	1856
ACE-400	400	250	-	971/1250/A	-	-	-	1640	2050	1240	-	2063
ACE-450	450	250	-	1456/A	-	-	-	1845	-	1445	-	2271
ACE-500	500	250	-	1663/A	-	-	-	2050	-	1650	-	2380
ACE-560	560	250	-	-	-	-	-	-	-	1856	-	-
ACE-630	630	250	-	-	-	-	-	2563	-	2063	-	-
ACE-710	710	250	-	-	-	-	-	-	-	2271	-	-
ACE-800	800	310	-	-	-	-	-	-	-	2380	-	-

ASPIRACIÓN

Modelo	Dimensiones		CMAT CMA	CB	CAS CAS	CA	CAM	CMP	CMT	CBP	CMR	CMC	CMRT
	ØD*	L											
ACE-52	52	130	-	-	-	-	-	-	-	-	-	-	-
ACE-63	63	200	-	-	-	-	-	-	-	-	-	-	-
ACE-80	80	200	218/324	-	-	-	-	-	-	-	-	-	-
ACE-100	100	200	325	-	242	234/142	-	-	-	-	-	-	-
ACE-112	112	200	426	-	248	148	-	512	-	-	-	-	-
ACE-125	125	200	527/528	-	254	154	-	-	-	-	-	-	-
ACE-140	140	200	-	-	-	-	-	514	-	-	-	-	-
ACE-150	150	200	531	-	260	160	-	-	-	-	-	628/630	-
ACE-160	160	190	-	-	-	-	-	616	-	-	-	-	-
ACE-180	180	190	540/545	-	680/790	166/172	540/545	718	922	-	-	-	-
ACE-200	200	190	-	820	463	-	-	620/820	1025	-	-	835/840	-
ACE-224	224	190	-	-	467	-	550/752	922	1128	-	-	-	-
ACE-250	250	250	-	1428	571/640/645 650/980/1080	-	760	1025	1231	-	-	-	-
ACE-280	280	250	-	1773	852/990/1090	-	-	1128	1435/1640	-	-	-	-
ACE-315	315	250	-	-	-	-	880	1231	-	-	1031	-	1650
ACE-355	355	250	-	2240	856/863/1250/A	-	-	1435	1845	-	1135	-	1856
ACE-400	400	250	-	-	971/1456/A	-	-	1640	2050	-	1240	-	2063
ACE-450	450	250	-	-	-	-	-	1845	-	-	1445	-	2271
ACE-500	500	250	-	-	-	-	-	2050	-	-	1650	-	2380
ACE-560	560	250	-	-	1663/A	-	-	-	-	-	1856	-	-
ACE-630	630	250	-	-	-	-	-	2563	-	-	2063	-	-
ACE-710	710	250	-	-	-	-	-	-	-	-	2271	-	-
ACE-800	800	310	-	-	-	-	-	-	-	-	2380	-	-

* Diámetro nominal tubería.

ACE/400

Brida de acoplamiento elástica, para trabajar a 400° C / 2 h.

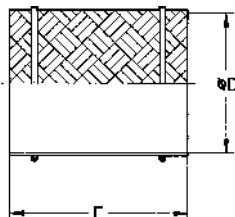

Dimensiones

Aplicable a los modelos

Modelo	Dimensiones		THT	CTMP-TCMP	TCR/TCR-R
	ØD*	L			
ACE/400-200	200	200	-	820	-
ACE/400-224	224	200	-	922	-
ACE/400-250	250	300	-	1025	-
ACE/400-280	280	300	-	1128	-
ACE/400-315	315	300	-	1231	-
ACE/400-355	355	300	-	1435	-
ACE/400-400	400	300	40	1640	1240
ACE/400-450	450	300	45	1845	1445
ACE/400-500	500	300	50	2050	1650
ACE/400-560	560	300	56	-	1856
ACE/400-630	630	300	63	-	2063
ACE/400-710	710	300	71	-	2271
ACE/400-800	800	300	80	-	-
ACE/400-900	900	300	90	-	-
ACE/400-1000	1000	300	100	-	-
ACE/400-1250	1250	300	125	-	-

* Diámetro nominal tubería.

ACCESORIOS



REG



Registro de regulación

Su construcción permite incorporarlos en los sistemas de conductos. El mando del registro está dotado de indicaciones que marcan la colocación de la mariposa de 0 a 90°

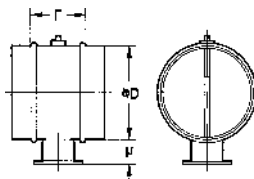

Dimensiones

Modelo	L	ØD	h
REG-80	100	80	50
REG-100	100	100	50
REG-112	100	112	50
REG-125	100	125	50
REG-140	100	140	50
REG-150	100	150	50
REG-160	100	160	50
REG-180	100	180	50
REG-200	100	200	50
REG-224	100	224	50
REG-250	100	250	50
REG-280	100	280	50
REG-315	100	315	50
REG-355	100	355	50
REG-400	100	400	50
REG-450	150	450	50
REG-500	150	500	50
REG-560	150	560	50
REG-630	250	630	50
REG-800	250	800	50

PSB



Pie soporte para ventiladores centrífugos de baja presión

Formado por dos piezas.

Modelo	Aplicable a los modelos
PSB-1428	CB-1428
PSB-1733	CB-1733
PSB-19	CBD-CBX-1919
PSB-25	CBD-CBX-2525
PSB-28	CBD-CBX-2828
PSB-33	CBD-CBX-3333
PSB-39	CBD-CBX-3939
PSB-47	CBX-4747

SM



Soporte motor con tensor correa para Ventiladores Centrífugos de baja presión.

Modelo	Aplicable a los modelos
SM-19	CBX-1919
SM-25	CBX-2525
SM-28	CBX-2828
SM-33	CBX-3333
SM-39	CBX-3939
SM-47	CBX-4747

CM

Cubre motores para la serie CJTX.

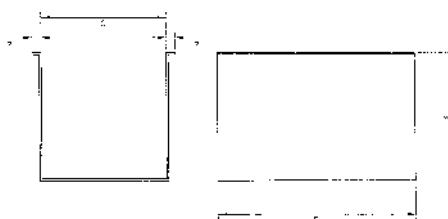

Modelo	Dimensiones				Aplicable a motores de: CV
	A	B	C	D	
CM-1	25	250	280	310	0,25 a 1
CM-2	25	270	280	380	1,5 a 2
CM-4	25	300	380	410	3 a 4
CM-5,5	25	330	380	440	5,5
CM-10	25	380	400	600	7,5 a 10
CM-20	25	480	500	700	15 a 20

ACCESORIOS



VIS

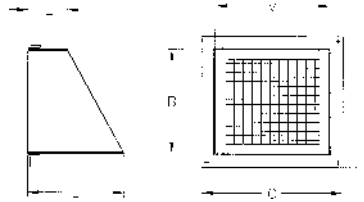
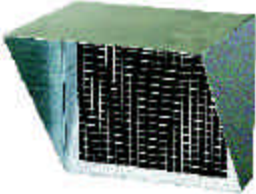

Viseras para impulsión con rejilla de protección.

Modelo	Dimensiones						Aplicable a los modelos						
	A	B	C	D	E	F	CJBD	CJBX	CJTX	CJMP	CJTCR/R	CJLINE	CJBR
VIS-7/7	238	216	-	-	200	80	1919	7/7	7/7	-	-	-	-
VIS-9/9	305	268	-	-	200	80	2525	9/9	9/9	-	-	-	-
VIS-10/10	330	296	-	-	200	80	2828	10/10	10/10	-	-	-	-
VIS-12/12	392	349	-	-	300	80	3333	12/12	12/12	-	-	-	-
VIS-15/15	479	409	-	-	300	80	3939	15/15	15/15	-	-	-	-
VIS-18/18	545	487	-	-	300	80	-	18/18	18/18	-	-	-	-
VIS-20/20	603	602	-	-	500	80	-	20/20	20/20	-	-	-	-
VIS-22/22	656	740	-	-	500	80	-	22/22	22/22	-	-	-	-
VIS-25/25	765	792	-	-	500	80	-	25/25	25/25	-	-	-	-
VIS-30/28	888	932	-	-	500	80	-	30/28	30/28	-	-	-	-
VIS-820	132	157	-	-	170	56,5	-	-	-	820	-	-	-
VIS-922	142	216	-	-	215	56,5	-	-	-	922	-	-	-
VIS-1025	167	251	-	-	240	56,5	-	-	-	1025	-	-	-
VIS-1128	182	296	-	-	270	56,5	-	-	-	1128	-	-	-
VIS-1231	202	321	-	-	290	56,5	-	-	-	1231	-	-	-
VIS-1240	317	401	-	-	350	56,5	-	-	-	-	1240	-	-
VIS-1435	232	281	-	-	260	56,5	-	-	-	1435	-	-	-
VIS-1445	357	451	-	-	385	56,5	-	-	-	-	1445	-	-
VIS-1640	252	321	-	-	290	56,5	-	-	-	1640	-	-	-
VIS-1650	402	501	-	-	420	56,5	-	-	-	-	1650	-	-
VIS-1845	286	361	-	-	320	56,5	-	-	-	1845	-	-	-
VIS-1856	452	561	-	-	465	56,5	-	-	-	-	1856	-	-
VIS-2050	317	451	-	-	385	56,5	-	-	-	2050	-	-	-
VIS-2063	502	631	-	-	515	56,5	-	-	-	-	2063	-	-
VIS-2271	562	716	-	-	575	56,5	-	-	-	-	2271	-	-
VIS-1131	560	450	-	-	250	100	-	-	-	-	-	1131	-
VIS-1235	620	500	-	-	250	100	-	-	-	-	-	1235	-
VIS-1640E	710	560	-	-	250	100	-	-	-	-	-	1640	-
VIS-1845E	800	630	-	-	250	100	-	-	-	-	-	1845	-
VIS-1856E	1000	800	-	-	250	100	-	-	-	-	-	1845	-
VIS-2063E	1120	900	-	-	250	100	-	-	-	-	-	2063	-
VIS-2271E	1190	900	-	-	250	100	-	-	-	-	-	2271	-
VIS-2880	1250	1000	-	-	250	100	-	-	-	-	-	2880	-
VIS-100	600	600	698	698	485	-	-	-	-	-	-	-	1240 1850
VIS-200	725	725	823	823	576	-	-	-	-	-	-	-	2056 2263-6T
VIS-300	800	800	898	898	630	-	-	-	-	-	-	-	2263-4T 2071-6T-3
VIS-400	860	860	958	958	674	-	-	-	-	-	-	-	2071-4T / 6T-5,5 2880

TEJ

Tejadillo intemperie.

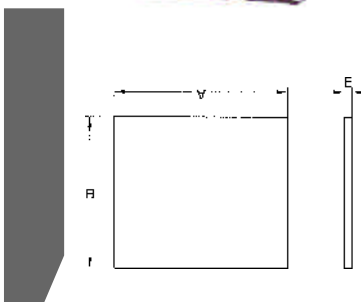

Modelo	Dimensiones						Aplicable a los modelos							
	A	CJBD	B	A	CJBX	B	A	B	E	CJBD	CJBX	CJMP	CJTCR/R	CJBR
TEJ-7/7	550	600	750	600	-	-	25	1919	7/7	-	-	-	-	-
TEJ-9/9	600	650	800	650	-	-	25	2525	9/9	-	-	-	-	-
TEJ-10/10	650	700	850	700	-	-	25	2828	10/10	-	-	-	-	-
TEJ-12/12	750	800	950	800	-	-	25	3333	12/12	-	-	-	-	-
TEJ-15/15	800	900	1100	900	-	-	25	3939	15/15	-	-	-	-	-
TEJ-18/18	-	-	1300	1100	-	-	25	-	18/18	-	-	-	-	-
TEJ-20/20	-	-	1400	1200	-	-	25	-	20/20	-	-	-	-	-
TEJ-22/22	-	-	1500	1350	-	-	25	-	22/22	-	-	-	-	-
TEJ-25/25	-	-	1600	1550	-	-	25	-	25/25	-	-	-	-	-
TEJ-30/28	-	-	1900	1750	-	-	25	-	30/28	-	-	-	-	-
TEJ-820	-	-	-	-	500	550	26	-	-	820	-	-	-	-
TEJ-922	-	-	-	-	710	710	26	-	-	922	-	-	-	-
TEJ-1025	-	-	-	-	760	760	26	-	-	1025	-	-	-	-
TEJ-1128	-	-	-	-	820	820	26	-	-	1128	-	-	-	-
TEJ-1231	-	-	-	-	900	900	26	-	-	1231	-	-	-	1240/1850
TEJ-1435	-	-	-	-	980	980	26	-	-	1435	-	-	-	-
TEJ-1640	-	-	-	-	1070	1070	26	-	-	1640	1240	2056/2263-6T	-	-
TEJ-1845	-	-	-	-	1170	1170	26	-	-	1845	1445	2263-4T/2071/2280	-	-
TEJ-1856	-	-	-	-	1360	1150	26	-	-	-	-	1856	-	-
TEJ-2050	-	-	-	-	1260	1260	26	-	-	2050	1650	-	-	-
TEJ-2063	-	-	-	-	1500	1300	26	-	-	-	2063	-	-	-
TEJ-2271	-	-	-	-	1655	1455	26	-	-	-	2271	-	-	-

ACCESORIOS



TAC



Tapa de acoplamiento circular.

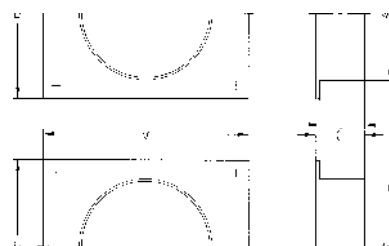

Modelo	Dimensiones					Aplicable a los modelos CJS	
	A	B	C	ØD	E	CJBR	CJLINE
TAC-100	698	698	80	400	50	1240 1850	-
TAC-200	823	823	80	560	50	2056 2263-6T	-
TAC-300	898	898	80	630	50	2263-4T 2071-6T-3	-
TAC-400	958	958	80	710	50	2071-4T/6T-5,5 2880	-
TAC-1131	615	505	165	400	150	-	1131
TAC-1235	695	575	165	450	150	-	1235
TAC-1640	785	635	165	500	150	-	1640
TAC-1845	875	705	165	560	150	-	1645
TAC-1856	1075	875	165	700	150	-	1856
TAC-2063	1195	975	165	800	150	-	2063
TAC-2271	1265	975	165	800	150	-	2271
TAC-2880	1325	1075	165	900	150	-	2880



VOL

Carcasa envolvente para la serie CMRH

Envolvente para ventilador CMRH, especialmente diseñada para ser montada en el interior del horno.

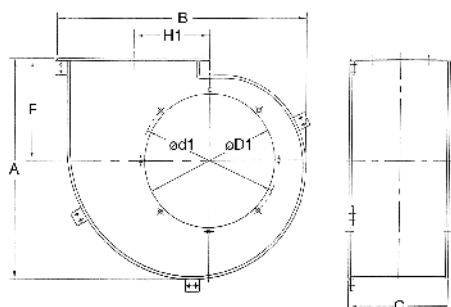

Modelo	Dimensiones							Aplicable a los modelos
	A	B	C	E	H1	Ød1	ØD1	
VOL-1445	765	882	359	350	271	494	465,5	CMRH-1445
VOL-1650	831	969	404	375	297	555	522,5	CMRH-1650
VOL-1856	923	1082	456	415	328	615	585	CMRH-1856
VOL-2063	1032	1231	508	465	365	688	655	CMRH-2063
VOL-2271	1168	1369	568	525	416	768	735	CMRH-2271



ARO

Boca de aspiración para la serie CMRH.

Aro de aspiración para la serie CMRH, especialmente diseñado para poner en la boca de aspiración de la turbina y así obtener el máximo rendimiento del ventilador de recirculación.

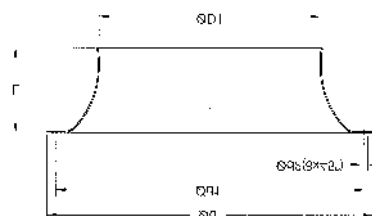

Modelo	Dimensiones					Aplicable a los modelos
	Ød	Ød1	ØD1	Ød2	L	
ARO-1445	522	494	354	12	159	CMRH-1445
ARO-1650	582	555	397	12	182	CMRH-1650
ARO-1856	645	615	446	12	198,5	CMRH-1856
ARO-2063	720	688	502	13	221	CMRH-2063
ARO-2271	800	768	562	13	268,5	CMRH-2271

CJACUS



Cajas acústicas

- Caja de ventilación construida en chapa galvanizada con aislamiento acústico
- Pies soporte y Silent-Blocks incluidos.

CJACUS/C

- Con conexión de aspiración e impulsión al exterior, por medio de conductos
- Rejilla para la refrigeración del motor.

CJACUS/L

- Con aspiración libre por medio de rejilla incorporada en la caja y conexión de impulsión al exterior.

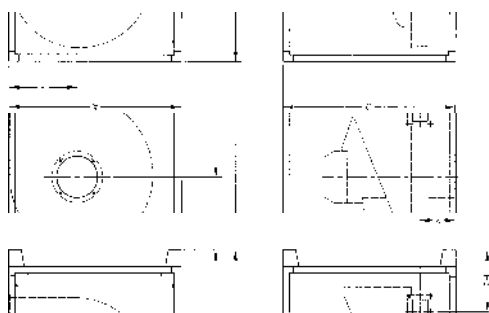

LG 270

Modelo	Dimensiones A B C			Aplicable a los modelos														
				CAS CAST					CA					CAM				
				Mod	E	H	H2	Y	Mod	E	H	H2	Y	Mod	E	H	H2	Y
CJACUS/C-0	820	1030	770	640	308	633	383	233	154	308	618	310	176	540	260	623	353	194
CJACUS/C-1	870	1070	800	254	338	633	341	138	160	339	663	327	188	545	298	673	363	204
				645	338	663	395	241	-	-	-	-	-	-	-	-	-	-
CJACUS/C-2	970	1150	900	260	378	708	346	155	166	372	713	341	165	550	319	733	383	244
				463	378	708	346	173	-	-	-	-	-	752	323	733	393	243
				650	378	708	408	251	-	-	-	-	-	-	-	-	-	-
CJACUS/C-3	1020	1250	950	467	398	753	358	216	172	398	739	335	248	-	-	-	-	-
				852	398	753	433	202	-	-	-	-	-	-	-	-	-	-
				856	398	753	433	201	-	-	-	-	-	-	-	-	-	-
CJACUS/C-4	1054	1300	1054	571	418	783	373	128	-	-	-	-	-	760	373	793	413	314
				863	418	783	458	286	-	-	-	-	-	-	-	-	-	-
CJACUS/C-5	1300	1470	1300	971	468	893	473	324	-	-	-	-	-	880	430	933	504	342

Nota: Para las dimensiones de las bocas de aspiración e impulsión, consultar catálogo según ventilador.

ACCESORIOS

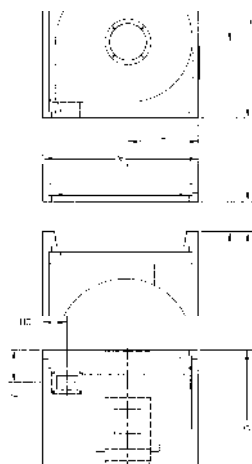

LG 0

Dimensiones

Aplicable a los modelos

Modelo	Dimensiones			CAS CAST					CA					CAM					
	A	B	C	Mod	E	H	H2	Y	Mod	E	H	H2	Y	Mod	E	H	H2	Y	
CJACUS/C-0	820	1030	770	640	365	633	205	233	154	365	618	147	176	540	340	623	210	194	
CJACUS/C-1	870	1070	800	254	390	633	158	138	160	385	663	147	188	545	370	673	190	204	
				645	390	663	213	241	-	-	-	-	-	-	-	-	-	-	-
CJACUS/C-2	970	1150	900	260	440	708	168	155	166	435	713	163	165	550	410	733	210	244	
				463	440	708	168	173	-	-	-	-	752	410	733	220	243	-	-
				650	440	708	230	251	-	-	-	-	-	-	-	-	-	-	-
CJACUS/C-3	1020	1250	950	467	460	753	165	216	172	460	739	156	248	-	-	-	-	-	
				852	460	753	240	202	-	-	-	-	-	-	-	-	-	-	-
				856	460	753	240	201	-	-	-	-	-	-	-	-	-	-	-
CJACUS/C-4	1054	1300	1054	571	477	783	167	128	-	-	-	-	-	760	447	793	227	314	
				863	477	783	252	286	-	-	-	-	-	-	-	-	-	-	
				971	580	893	300	324	-	-	-	-	-	-	-	-	-	-	
CJACUS/C-5	1300	1470	1300	971	580	893	300	324	-	-	-	-	-	880	550	933	315	342	

Nota: Para las dimensiones de las bocas de aspiración e impulsión, consultar catálogo según ventilador.

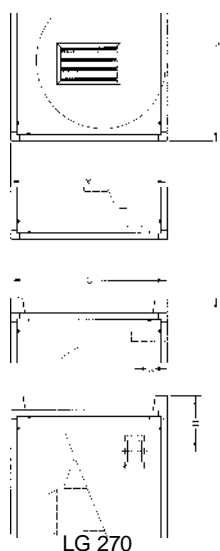

LG 270

Dimensiones

Aplicable a los modelos

Modelo	Dimensiones			CAS CAST			CA			CAM			
	A	B	C	Mod	H	Y	Mod	H	Y	Mod	H	Y	
CJACUS/L-0	820	1030	770	640	383	233	154	310	176	540	353	194	
CJACUS/L-1	870	1070	800	254	341	138	160	327	188	545	363	204	
				645	395	241	-	-	-	-	-	-	-
CJACUS/L-2	970	1150	900	260	346	155	166	341	165	550	383	244	
				463	346	173	-	-	-	752	393	243	-
				650	408	251	-	-	-	-	-	-	-
CJACUS/L-3	1020	1250	950	467	358	216	172	335	248	-	-	-	
				852	433	202	-	-	-	-	-	-	
				856	433	201	-	-	-	-	-	-	
CJACUS/L-4	1054	1300	1054	571	373	218	-	-	-	760	413	314	
				863	458	286	-	-	-	-	-	-	
CJACUS/L-5	1300	1470	1300	971	473	324	-	-	-	880	504	342	

Nota: Para las dimensiones de las bocas de aspiración e impulsión, consultar catálogo según ventilador.

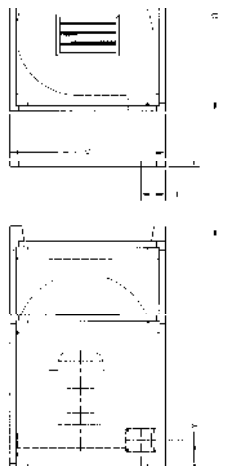

LG 0

Dimensiones

Aplicable a los modelos

Modelo	Dimensiones			CAS CAST			CA			CAM			
	A	B	C	Mod	H	Y	Mod	H	Y	Mod	H	Y	
CJACUS/L-0	820	1030	770	640	205	233	154	147	176	540	210	194	
CJACUS/L-1	870	1070	800	254	158	138	160	147	188	545	190	204	
				645	213	241	-	-	-	-	-	-	-
CJACUS/L-2	970	1150	900	260	168	155	166	163	165	550	210	244	
				463	168	173	-	-	-	752	220	243	-
				650	230	251	-	-	-	-	-	-	-
CJACUS/L-3	1020	1250	950	467	165	216	172	156	248	-	-	-	
				852	240	202	-	-	-	-	-	-	
				856	240	201	-	-	-	-	-	-	
CJACUS/L-4	1054	1300	1054	571	167	218	-	-	-	760	227	314	
				863	252	286	-	-	-	-	-	-	
CJACUS/L-5	1300	1470	1300	971	300	324	-	-	-	880	315	342	

Nota: Para las dimensiones de las bocas de aspiración e impulsión, consultar catálogo según ventilador.

ACCESORIOS



S Silenciadores

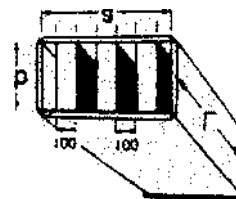

ASPIRACIÓN/IMPULSIÓN (Sección rectangular).

Modelo	Dimensiones				Amortiguación de sustitución (dB) en banda de octavos (Hz)						Aplicable
	L	a	b	Kg	125	250	500	1000	2000	4000	
SR-1000/900/900	900	1000	900	64	4	10	21	37	44	37	HCH/HCT-63
SR-1200/900/900	900	1200	900	74	4	10	21	37	44	37	HCH/HCT-71
SR-1400/1200/900	900	1400	1200	102	4	12	25	41	47	42	HCH/HCT-80
SR-1800/1200/1200	1200	1800	1200	169	4	12	25	41	47	42	HCH/HCT-90
SR-1800/1500/1200	1200	1800	1504	195	4	12	25	41	47	42	HCH/HCT-100

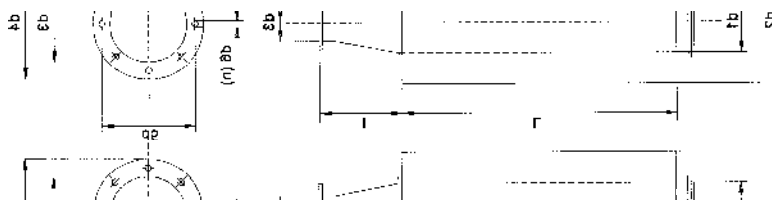

ASPIRACIÓN/IMPULSIÓN (Sección circular).

Modelo	Dimensiones										Amortiguación de sustitución (dB) en banda de octavos (Hz)						Aplicable
	L	d1	d2	l	d3	d4	d5	d6	n	Kg	125	250	500	1000	2000	4000	
SC-630/900	900	630	800	100	630	720	690	12	12x30°	44	5	8	14	12	13	9	HCH/HCT-63
SC-710/900	900	710	900	100	710	800	770	12	16x22°30'	65	5	8	13	11	12	8	HCH/HCT-71
SC-800/900	900	800	1000	100	800	900	860	12	16x22°30'	70	4	8	11	9	9	8	HCH/HCT-80
SC-900/1200	1200	900	1120	100	900	1000	970	15	16x22°30'	87	5	7	11	11	7	5	HCH/HCT-90
SC-1000/1200	1200	1000	1200	100	1000	1100	1070	15	16x22°30'	95	4	7	11	10	7	6	HCH/HCT-100

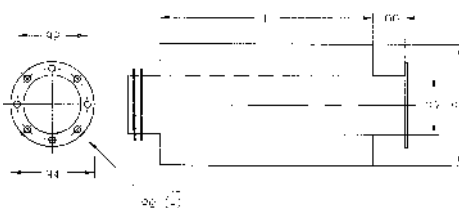

ASPIRACIÓN

Modelo	Dimensiones								Amortiguación de sustitución (dB) en banda de octavos (Hz)						Aplicable
	L	d2	d3	d4	d5	d6	n	Kg	125	250	500	1000	2000	4000	
S-160/600	600	260	160	220	200	10	4x90°	6	3	11	22	33	42	29	CHRE-722
S-180/600	600	300	180	240	210	10	4x90°	7	4	8	15	31	28	20	CHRE-825
S-250/600	600	450	250	310	280	10	4x90°	14	5	12	20	24	23	14	CHT-200/225 HT-25 CHRE-1131
S-315/900	900	500	315	390	355	10	8x45°	22	4	12	21	26	19	15	HT-31 CMRT-1650
S-355/900	900	560	355	430	395	10	8x45°	25	4	12	20	24	18	14	CHT-250/315 HT-35 CHRE-1135/1240 CMRT-1856
S-400/900	900	600	400	480	450	12	8x45°	29	5	12	19	22	18	13	HT-40 CMRT-2063
S-450/900	900	630	450	530	500	12	8x45°	32	5	12	18	20	16	12	HT-45 CMRT-2271
S-500/900	900	710	500	590	560	12	12x30°	35	4	11	18	16	14	11	CHT-400/450 HT-50 CHRE-1445/1650
S-560/900	900	750	560	650	620	12	12x30°	41	4	10	16	14	13	10	HT-56
S-630/900	900	800	630	720	690	12	12x30°	44	5	8	14	12	13	9	CHT-500 HT-63
S-710/900	900	900	710	800	770	12	16x22°30'	65	5	8	13	11	12	8	CHT-560/630 HT-71
S-800/900	900	1000	800	900	860	12	16x22°30'	70	4	8	11	9	9	8	HT-80
S-900/1200	1200	1120	900	1000	970	15	16x22°30'	85	5	7	11	11	7	6	HT-90
S-1000/1200	1200	1200	1100	1100	1070	15	16x22°30'	95	4	7	11	10	7	6	HT-100

ACCESORIOS

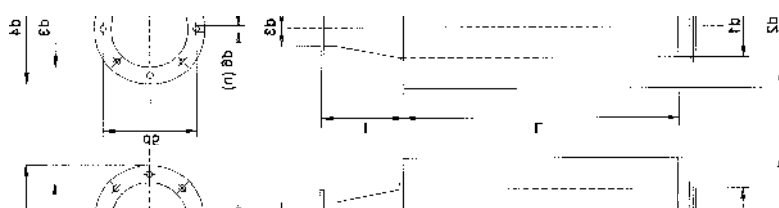

ASPIRACIÓN

Modelo	Dimensiones									Kg	Amortiguación de sustitución (dB) en banda de octavos (Hz)						Aplicable
	L	d1	d2	l	d3	d4	d5	d6	n		125	250	500	1000	2000	4000	
S-80/600/218-A	600	80	280	103	80	113	95	6	4x90°	6	17	26	29	53	53	45	CMA-218
S-100/600/324-A	600	100	300	108	80	130	112	6	4x90°	8	13	23	34	46	52	40	CMA-324
S-125/600/325-A	600	125	315	114	94	140	122	7	4x90°	8	11	20	30	40	45	30	CMA-325
S-150/600/426-A	600	150	355	132	117	155	132	7	4x90°	9	10	19	29	37	42	25	CMA-426
S-150/600/527-A	600	150	355	114	125	170	147	7	4x90°	9	10	19	29	37	42	25	CMA-527
S-160/600/528-A	600	160	355	107	135	190	162	7	4x90°	9	9	16	28	33	37	21	CMA-528
S-200/600/531-A	600	200	400	135	160	215	180	7	4x90°	12	6	12	22	28	28	18	CMA-531
S-250/600/540-A	600	250	450	204	170	240	205	11	4x90°	14	5	12	20	24	23	14	CMA-540
S-315/900/545-A	900	315	500	266	180	255	220	11	4x90°	22	4	12	21	26	19	15	CMA-545
S-150/600/628-A	600	150	355	100	150	200	192	7	8x45°	9	10	19	29	37	42	25	CMC-628
S-150/600/630-A	600	150	355	100	150	200	192	7	8x45°	9	10	19	29	37	42	25	CMC-630
S-200/600/835-A	600	200	400	100	200	250	230	9	8x45°	12	6	12	22	28	28	18	CMC-835
S-200/600/840-A	600	200	400	100	200	250	230	9	8x45°	12	6	12	22	28	28	18	CMC-840
S-100/600/242-A	600	100	300	115	100	150	130	10	8x45°	8	13	23	34	46	52	40	CAS/CAST-242
S-150/900/248-A	900	150	355	200	112	160	140	10	8x45°	11	10	27	37	51	53	37	CAS/CAST-248
S-160/900/254-A	900	160	355	200	125	180	155	10	8x45°	12	11	24	35	49	51	27	CAS/CAST-254
S-200/900/260-A	900	200	400	200	150	210	175	10	8x45°	17	8	18	28	40	37	23	CAS/CAST-260
S-200/900/463-A	900	200	400	200	200	260	240	10	8x45°	17	8	18	28	40	37	23	CAS/CAST-463
S-250/900/467-A	900	250	450	200	224	280	258	10	8x45°	22	6	17	30	34	28	17	CAS/CAST-467
S-250/900/571-A	900	250	450	200	250	310	275	10	8x45°	22	6	17	30	34	28	17	CAS/CAST-571
S-250/600/640-A	600	250	450	200	250	310	275	10	8x45°	14	5	12	20	24	23	14	CAS/CAST-640
S-315/900/645-A	900	315	500	200	250	310	275	10	8x45°	22	4	12	21	26	19	15	CAS/CAST-645
S-355/900/650-A	900	355	560	200	250	310	275	10	8x45°	25	4	12	20	24	18	14	CAS/CAST-650
S-180/900/680-A	900	180	380	100	165	235	200	11	8x45°	14	9	21	31	44	44	25	CAS-680
S-180/900/790-A	900	180	380	100	185	235	219	11	8x45°	14	9	21	31	44	44	25	CAS-790
S-355/900/852-A	900	355	560	200	280	350	310	10	8x45°	25	4	12	20	24	18	14	CAS/CAST-852
S-400/1200/856-A	1200	400	600	200	355	430	395	10	8x45°	38	7	16	22	29	22	15	CAS/CAST-856
S-400/1200/863-A	1200	400	600	200	355	430	410	10	8x45°	38	7	16	22	29	22	15	CAS/CAST-863
S-450/1200/971-A	1200	450	630	200	400	480	450	12	8x45°	42	6	15	21	25	20	14	CAS/CAST-971
S-250-1200/980-A	1200	250	450	100	255	325	292	11	8x45°	28	9	22	35	39	33	20	CAS-980
S-280/1200/990-A	1200	280	450	100	286	366	332	11	8x45°	32	8	18	31	38	28	19	CAS-990
S-250/1200/1080-A	1200	250	450	100	255	325	292	11	8x45°	28	9	22	35	39	33	20	CAS-1080
S-280/1200/1090-A	1200	280	450	100	286	366	332	11	8x45°	32	8	18	31	38	28	19	CAS-1090
S-500/900/1250-A	900	300	600	300	361	441	405	11,5	8x45°	56	6	13	18	15	15	12	CAS/CAST-1250/A
S-560/900/1456-A	700	560	630	450	406	486	448	11,5	12x30°	65	5	8	13	11	12	8	CAS/CAST-1456/A
S-630/1200/1663-A	1200	630	750	450	568	668	629	11,5	16x22°30'	70	4	8	11	9	9	8	CAS/CAST-1663/A
S-80/600/234-A	600	80	280	108	98	130	115	5	6x60°	6	17	26	29	53	53	45	CA-234
S-100/600/142-A	600	100	300	108	90	160	130	9	4x90°	8	13	23	34	46	52	40	CA-142
S-150/900/148-A	900	150	355	149	100	170	140	9	4x90°	11	10	27	37	51	53	37	CA-148
S-160/900/154-A	900	160	355	146	115	183	155	11	4x90°	12	11	24	35	49	51	27	CA-154
S-200/900/160-A	900	200	400	183	130	230	192	11	4x90°	17	8	18	28	40	37	23	CA-160
S-200/900/166-A	900	200	400	162	140	230	200	11	4x90°	17	8	18	28	40	37	23	CA-166
S-200/900/172-A	900	200	400	149	148	230	200	11	4x90°	17	8	18	28	40	37	23	CA-172
S-250/600/540-A	600	250	450	204	170	240	205	11	4x90°	14	5	12	20	24	23	14	CAM-540
S-315/900/545-C-A	900	315	500	266	165	235	205	11	4x90°	22	4	12	21	26	19	15	CAM-545
S-355/900/550-A	900	355	560	293	210	278	258	9	6x60°	25	4	12	20	24	18	14	CAM-550
S-355/900/752-A	900	355	560	260	220	278	258	9	6x60°	25	4	12	20	24	18	14	CAM-752
S-355/1200/760-A	1200	355	560	224	246	322	280	10	6x60°	32	7	15	25	32	23	17	CAM-760
S-500/1200/880-A	1200	500	710	360	290	360	330	10	12x30°	32	7	15	25	32	23	17	CAM-880
S-315/600/922-A	600	315	500	238	220	278	256	9	8x45°	16	4	8	14	17	14	12	CMP-922
S-355/900/1025-A	900	355	560	224	245	305	282	9	8x45°	25	4	12	20	24	23	14	CMP-1025
S-400/900/1128-A	900	400	600	250	270	348	320	9	8x45°	29	5	12	19	22	18	13	CMP-1128
S-450/900/1231-A	900	450	630	291	295	382	354	9	8x45°	32	5	12	18	20	16	12	CMP-1231
S-500/900/1435-A	900	500	710	284	345	422	394	9	8x45°	35	4	11	18	16	14	11	CMP-1435
S-500/900/1640-A	900	500	710	227	395	464	438	9	8x45°	35	4	11	18	16	14	11	CMP-1640
S-560/900/1845-A	900	560	750	241	445	515	485	9	8x45°	41	4	10	16	14	13	10	CMP-1845
S-630/1200/2050-A	1200	630	800	269	495	565	535	11	8x45°	56	6	13	18	15	15	12	CMP-2050
S-800/1200/2563-A	1200	800	1000	370	595	710	675	14	8x45°	80	5	9	13	11	11	9	CMP-2563
S-400/900/1031-A	900	400	600	202	320	383	356	9	8x45°	29	5	12	19	22	18	13	CMR-1031
S-450/900/1135-A	900	450	630	216	345	425	398	9	8x45°	32	5	12	18	20	16	12	CMR-1135
S-500/900/1240-A	900	500	710	227	395	472	444	11	8x45°	35	4	11	18	16	14	11	CMR-1240
S-560/900/1445-A	900	560	750	241	445	522	494	11	8x45°	41	4	10	16	14	13	10	CMR-1445
S-630/1200/1650-A	1200	630	800	269	495	582	555	11	8x45°	56	6	13	18	15	15	12	CMR-1650
S-710/900/1856-A	900	710	900	301	555	645	615	11	8x45°	65	5	8	13	11	12	8	CMR-1856
S-800/900/2063-A	900	800	1000	329	625	720	688	11	8x45°	70	4	8	11	9	9	8	CMR-2063
S-800/1200/2271-A	1200	800	1000	224	705	800	768	13	8x45°	80	5	9	13	11	11	9	CMR-2271
S-800/1200/2380-A	1200	800	1000	224	800	906	861	13	16x22°	90	5	9	13	11	11	9	CMR-2380
S-630/1200/2380-A	1200	630	800	269	495	582	551	11	12x30°	56	6	13	18	15	15	12	CMRT-2380

ACCESORIOS

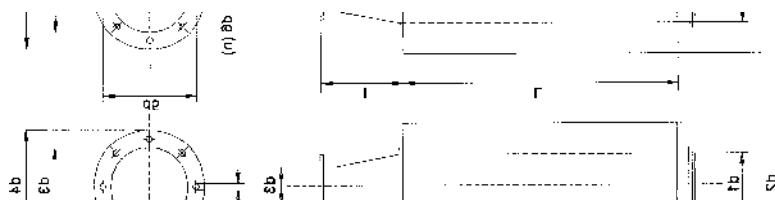

IMPULSIÓN (Brida circular).

Modelo	Dimensiones										Amortiguación de sustitución (dB) en banda de octavos (Hz)						Aplicable
	L	d1	d2	l	d3	d4	d5	d6	n	Kg	125	250	500	1000	2000	4000	
S-80/600/218-I	600	80	280	103	54	90	76	6	4x90°	6	17	26	29	53	53	45	CMA-218
S-100/600/324-I	600	100	300	131	62	110	90	7	4x90°	8	13	23	34	46	52	40	CMA-324
S-125/600/325-I	600	125	315	142	80	120	102	7	4x90°	8	11	20	30	40	45	30	CMA-325
S-150/600/426-I	600	150	355	176	90	140	119	7	4x90°	9	10	19	29	37	42	25	CMA-426
S-150/600/527-I	600	150	355	149	100	155	129	7	4x90°	9	10	19	29	37	42	25	CMA-527
S-160/600/528-I	600	160	355	138	130	190	160	11	4x90°	9	9	16	28	33	37	21	CMA-528
S-200/600/531-I	600	200	400	162	140	200	175	11	4x90°	12	6	12	22	28	28	18	CMA-531
S-250/600/540-I	600	250	450	217	150	220	190	13	4x90°	14	5	12	20	24	23	14	CMA-540
S-315/900/545-I	900	315	500	266	175	250	220	13	4x90°	22	4	12	21	26	19	15	CMA-545
S-80/600/234-I	600	80	280	103	40	100	72	9	2x180°	6	17	26	29	53	53	45	CA-234
S-100/600/142-I	600	100	300	131	60	120	90	11	4x90°	8	13	23	34	46	52	40	CA-142
S-150/900/148-I	900	150	355	176	73	150	110	11	4x90°	11	10	27	37	51	53	37	CA-148
S-160/900/154-I	900	160	355	190	80	160	120	13	4x90°	12	11	24	35	49	51	27	CA-154
S-200/900/160-I	900	200	400	245	85	160	120	13	4x90°	17	8	18	28	40	37	23	CA-160
S-200/900/166-I	900	200	400	245	85	160	120	13	4x90°	17	8	18	28	40	37	23	CA-166
S-200/900/172-I	900	200	400	245	90	175	140	13	4x90°	17	8	18	28	40	37	23	CA-172

ACCESORIOS

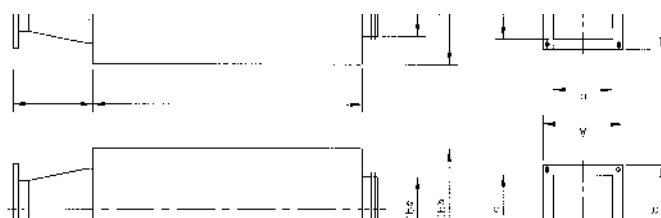

IMPULSIÓN (Sección rectangular)

Modelo	Dimensiones									Amortiguación de sustitución (dB) en banda de octavos (Hz)						
	L	d1	d2	l	a	b	A	B	Kg	125	250	500	1000	2000	4000	Aplicable
S-150/600/628-I	600	150	355	100	86	86	130	130	9	10	19	29	37	42	25	CMC-628
S-150/600/630-I	600	150	355	100	86	86	130	130	9	10	19	29	37	42	25	CMC-630
S-200/600/835-I	600	200	400	100	91	91	141	141	12	6	12	22	28	28	18	CMC-835
S-200/600/840-I	600	200	400	100	91	91	141	141	12	6	12	22	28	28	18	CMC-840
S-100/600/242-I	600	100	300	200	95	60	155	120	8	13	23	34	46	52	40	CAS/CAST-242
S-150/900/248-I	900	150	355	200	105	66	165	126	11	10	27	37	51	53	37	CAS/CAST-248
S-160/900/254-I	900	160	355	200	115	75	175	135	12	11	24	35	49	51	27	CAS/CAST-254
S-200/900/260-I	900	200	400	200	125	85	185	145	17	8	18	28	40	37	23	CAS/CAST-260
S-200/900/463-I	900	200	400	200	125	85	185	145	17	8	18	28	40	37	23	CAS/CAST-463
S-250/900/467-I	900	250	450	250	130	90	190	150	22	6	17	30	34	28	17	CAS/CAST-467
S-250/900/571-I	900	250	450	250	145	95	205	155	22	6	17	30	34	28	17	CAS/CAST-571
S-250/600/640-I	600	250	450	250	200	125	260	185	14	5	12	20	24	23	14	CAS/CAST-640
S-315/900/645-I	900	315	500	250	224	140	284	200	22	4	12	21	26	19	15	CAS/CAST-645
S-355/900/650-I	900	355	560	250	250	160	310	220	25	4	12	20	24	18	14	CAS/CAST-650
S-180/900/680-I	600	180	380	100	71	100	131	160	15	9	21	31	44	44	25	CAS-680
S-180/900/790-I	600	180	380	100	80	112	140	172	15	9	21	31	44	44	25	CAS-790
S-355/900/852-I	900	355	560	250	280	180	340	240	25	4	12	20	24	18	14	CAS/CAST-852
S-400/1200/856-I	1200	400	600	280	280	180	340	240	38	7	16	22	29	22	15	CAS/CAST-856
S-400/1200/863-I	1200	400	600	280	315	200	375	260	38	7	16	22	29	22	15	CAS/CAST-863
S-450/1200/971-I	1200	450	630	280	355	224	425	294	42	6	15	21	25	20	14	CAS/CAST-971
S-250/1200/980-I	1200	250	450	100	140	200	210	270	29	9	22	35	39	33	20	CAS-980
S-280/1200/990-I	1200	280	450	100	160	224	230	294	33	8	18	31	38	28	19	CAS-990
S-250/1200/1080-I	1200	250	450	100	140	200	210	270	29	9	22	35	39	33	20	CAS-1080
S-280/1200/1090-I	1200	280	450	100	160	224	230	294	33	8	18	31	38	28	19	CAS-1090
S-500/900/1250-I	900	500	600	300	280	400	360	480	9	6	13	18	15	15	12	CAS/CAST-1250/A
S-560/900/1456-I	900	560	630	450	315	450	395	530	9	5	8	13	11	12	8	CAS/CAST-1456/A
S-630/1200/1663-I	1200	630	750	450	355	500	435	580	12	4	8	13	11	11	9	CAS/CAST-1663/A
S-250/600/540-C-I	600	250	450	300	140	120	224	206	14	5	12	20	24	23	14	CAM-540
S-315/900/545-C-I	900	315	500	300	170	135	255	222	22	4	12	21	26	19	15	CAM-545
S-355/900/550-I	900	355	560	300	200	150	296	246	25	4	12	20	24	18	14	CAM-550
S-355/900/752-I	900	355	560	300	200	160	296	256	25	4	12	20	24	18	14	CAM-752
S-355/1200/760-I	1200	355	560	300	220	180	316	276	32	7	15	25	32	23	17	CAM-760
S-500/1200/880-I	1200	500	710	300	290	190	360	249	32	7	15	25	32	23	17	CAM-880
S-315/600/922-I	600	315	500	300	216	140	282	204	16	4	8	14	17	14	12	CMP-922
S-355/900/1025-I	900	355	560	300	250	165	314	229	25	4	12	20	24	23	14	CMP-1025
S-400/900/1128-I	900	400	600	300	300	180	364	244	29	5	12	19	22	18	13	CMP-1128
S-450/900/1231-I	900	450	630	300	320	200	384	266	32	5	12	18	20	16	12	CMP-1231
S-500/900/1435-I	900	500	710	300	280	228	344	294	35	4	11	18	16	14	11	CMP-1435
S-500/900/1640-I	900	500	710	300	320	250	404	336	35	4	11	18	16	14	11	CMP-1640
S-560/900/1845-I	900	560	750	450	360	284	444	370	41	4	10	16	14	13	10	CMP-1845
S-630/1200/2050-I	1200	630	800	450	450	315	545	412	56	6	13	18	15	15	12	CMP-2050
S-800/1200/2563-I	1200	800	1000	450	600	410	706	512	80	5	9	13	11	11	9	CMP-2563
S-400/900/1031-I	900	400	600	300	315	250	385	320	29	5	12	19	22	18	13	CMR-1031
S-450/900/1135-I	900	450	630	450	355	280	425	350	32	5	12	18	20	16	12	CMR-1135
S-500/900/1240-I	900	500	710	450	400	315	480	395	35	4	11	18	16	14	11	CMR-1240
S-560/900/1445-I	900	560	750	450	450	355	540	445	41	4	10	16	14	13	10	CMR-1445
S-630/1200/1650-I	1200	630	800	450	500	400	590	490	56	6	13	18	15	15	12	CMR/CMRT-1650
S-710/900/1856-I	900	710	900	450	560	450	660	550	65	5	8	13	11	12	8	CMR/CMRT-1856
S-800/900/2063-I	900	800	1000	450	630	500	750	620	70	4	8	11	9	9	8	CMR/CMRT-2063
S-800/1200/2271-I	1200	800	1000	450	710	560	840	690	80	5	9	13	11	11	9	CMR/CMRT-2271
S-800/1201/2380-I	1200	800	1000	450	560	800	680	920	90	5	9	13	11	11	9	CMR-2380
S-800/1200/2380-I	1200	800	1000	450	560	1120	690	1246	90	5	9	13	11	11	9	CMR-2380-X

Ventiladores bajo demanda



Aprovechando la estructura de fabricación de SODECA, y con los medios de diseño y ensayo que disponemos, podemos suministrar con toda garantía ventiladores industriales de gran tamaño, contruídos con una robustez fuera de lo habitual. Dichos ventiladores son adecuados para la industria pesada, refinerías, centrales nucleares, plantas de cemento, grandes obras y otras muchas aplicaciones de aspiración de ambientes sucios y corrosivos o aportes de aire.

Ventiladores con motor directo



CMR

Diámetro turbina hasta 1.000 mm
Potencia instalada hasta 75 Kw
Caudal máximo 96.000 m³/h
Presión total máxima 400 mmcda
Aplicación: aspiración de aire limpio o ligeramnete polvoriento.



CAM

Diámetro turbina hasta 1.121 mm
Potencia instalada hasta 55 Kw
Caudal máximo 54.000 m³/h
Presión total máxima 570 mmcda
Aplicación: aspiración de aire con gran cantidad de polvo en suspensión.



CAS

Diámetro turbina hasta 1.800 mm
Potencia instalada hasta 560 Kw
Caudal máximo 150.000 m³/h
Presión total máxima 2.500 mmcda
Aplicación: Para impulsión de aire en transportes neumáticos, quemadores, o aspiración de aire limpio o ligeramente polvoriento.



CMT

Diámetro turbina hasta 1.121 mm
Potencia instalada hasta 110 Kw
Caudal máximo 54.000 m³/h
Presión total máxima 1.000 mmcda
Aplicación: aspiración de material sólido mezclado con aire. Muy apropiado para transporte de serrín y recortes.

Ventiladores con accionamiento a transmisión



CMR-X

Diámetro turbina hasta 1.600mm
Potencia instalada hasta 200 Kw
Caudal máximo 220.000 m³/h
Presión total máxima 400 mmcda
Aplicación: aspiración de aire limpio o ligeramente polvoriento.



CAM-X

Diámetro turbina hasta 1.800 mm
Potencia instalada hasta 315 Kw
Caudal máximo 200.000 m³/h
Presión total máxima 800 mmcda
Aplicación: aspiración de aire con gran cantidad de polvo en suspensión.



CAS-X

Diámetro turbina hasta 1.800 mm
Potencia instalada hasta 560 Kw
Caudal máximo: 180.000 m³/h
Presión total máxima 2.200 mmcda
Aplicación: Para impulsión de aire en transportes neumáticos, quemadores, o aspiración de aire polvoriento.



CMT-X

Diámetro turbina hasta 1.600 mm
Potencia instalada hasta 220 Kw
Caudal máximo 120.000 m³/h
Presión total máxima 1.000 mmcda
Aplicación: aspiración de material sólido mezclado con aire. Muy apropiado para transporte de serrín y recortes.